

Butterfly Valve 565

Beats metal in every round

Lightweight, highly reliable
and cost-effective



A robust lightweight

Plastic Butterfly Valves have already proven to outperform metal valves in almost every way, thanks to a higher resistance against corrosion and a lighter weight. Now, a new generation has arrived to beat metal in cost-effectiveness, too.

The new Butterfly Valve 565 is the best choice for optimizing piping systems built for water applications and a wide range of other applications. This new generation comes at a significantly lower initial cost, and will save even more thanks to its lower static weight, requiring less energy for both operation and transportation. Installing the Butterfly Valve 565 is quick and easy, but thanks to its extremely high durability, it will be almost maintenance-free during its long service life.

+ Direct Replacement

The Butterfly Valve 565 comes in the same installation length as metal solutions. The exchange does not require any additional work on the pipes or new designs. This reduces the effort of both planning and installation, also thanks to a lighter weight.

+ 60% lighter

Thanks to its low weight, a single person can lift and install the Butterfly Valve 565 in just a few minutes. This also facilitates planning, since the low weight significantly reduces the need for costly transportation and personnel.

+ Highly reliable

The Butterfly Valve 565 is built to last. High-performance thermoplastics protect it from abrasion and corrosion. This guarantees a longer system lifetime, even under harsh conditions such as water hammers. The results are a reduction of both maintenance costs and production stops.



+ Reduced costs

With the initial cost being comparable to metal solutions, the Butterfly Valve 565 outperforms its metal counterparts in the long run, reducing maintenance costs, thanks to its superior materials and design.

+ Ready for digitization

With its standard interface, the Butterfly Valve 565 can be upgraded with various modules, such as the smart actuator. This allows for automation and digitization of your systems, making them even more cost-effective and efficient.

+ Swiss quality

The Butterfly Valve 565 is produced by GF Piping Systems in Seewis (Grisons), Switzerland. High-quality valves have been produced here for over half a century. They combine technological innovation with the highest standards of material selection, manufacturing and quality testing for safety, durability and reliability.



To ensure the high quality standard, the butterfly valves are tested under the toughest conditions in a test stand.

How plastic wins against corrosion and gravity

More than half a century ago, GF Piping Systems decided to switch from metal to plastic. This was both a revolutionary and a forward-looking step, as the disadvantages of metal have proven to be the advantages of plastic. The Butterfly Valve 565 is the newest product of this innovation process, outperforming its metal counterparts in every way.



✓	Short installation length	✓
✓	Light weight	✗
✓	Corrosion resistant	✗
✓	High p/T performance	✓

Technical Data

Dimension	DN50-300, 2" - 12"
Pressure rating	DN50-150: PN16 / DN200-250: PN10 / DN300: PN6
Materials	Wafer: fibre reinforced polyamide (PA6-60) Disc: PVDF with fibre reinforced polyamide (PA6-60)
Sealing material	EPDM, FKM
Shaft material	Stainless steel, 1.4104 (430 F), Other shaft material on request
Installation length	EN558 row 20, ISO 5752 row 20, API 609 table 2
Flange standards	ISO 7005 PN10/16, EN 1092 PN10/16, DIN 2501 PN10/16, ANSI/ASME B 16.5 Class 150, BS 1560: 1989 Class 125/150; BS 4504 PN10/16, JIS B 2220 10K, JIS B 2239 10K
Mounting flange	EN ISO 5211
Leak test	ISO 9393-2, EN 12266 (leak rate A), ISO 5208 (Rate A)
Approvals	Multiple approvals available on request
Actuation variants	Manual: lockable hand lever or reduction gear with hand wheel Pneumatic: FC; FO; DA Electric: AC: 100, 230 V, AC/DC: 24 V, Smart Version

Sustainably future-proof

GF Piping Systems is making flow sustainable: Environmental regulations, water scarcity and an increasing demand of consumers and society for greener and more sustainable solutions are an important set of trends shaping customer behavior. The Butterfly Valve 565 is another important milestone in building a more sustainable future.

+ Lower production footprint

The waste of energy and resources in industrial production is reduced further by the long service life, thanks to a higher resistance against corrosion.

+ Lower overall costs

The low weight of the plastic material reduces the energy and resources needed for transport and installation. After installation, the advantages of the reduced static weight can become even more significant.

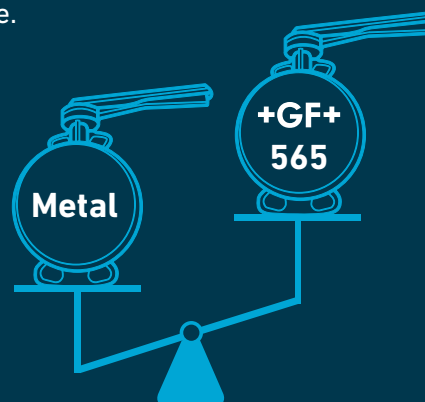

+ 10 tons weight saved

Replacing 600 metal butterfly valves with the new plastic Butterfly Valve 565 will save up to 10 tons in weight and reduce CO₂ emissions.

Superior material meets modular design

When something is built to last, it is all the more important that it can be flexibly adapted to changing requirements. For high-quality plastic materials optimized for durability, modular design is the perfect match. The standard interface also ensures that the Butterfly Valve 565 stays upgradeable during its long lifespan, fit for the ever-evolving future.

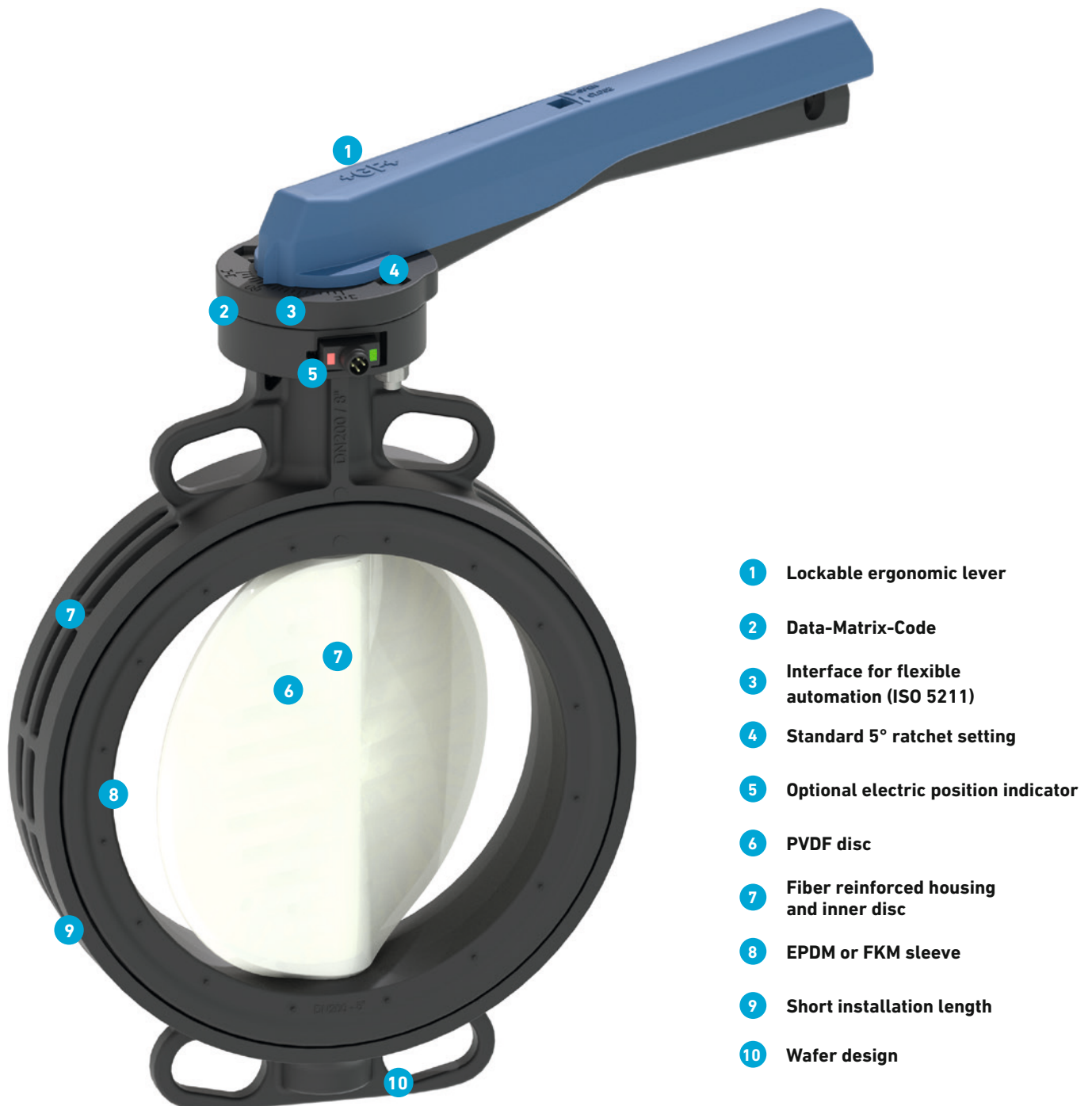

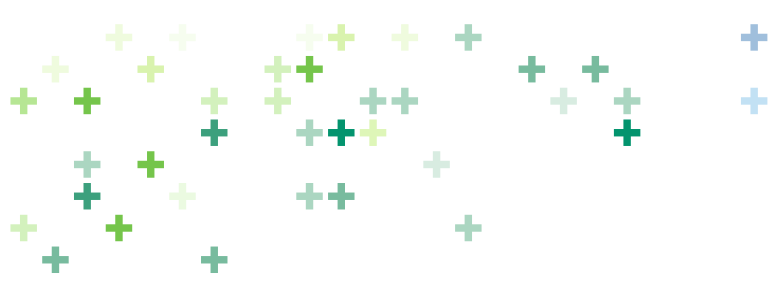

Modular process automation

Smart actuator for more efficiency in the work process

The smart actuator makes full use of the possibilities of digitization: Thanks to the app, you can access it at any time in order to read data or carry out settings, for example. This makes work easier and more efficient than ever before.

Electric actuator for highest reliability and ease of use

Powered by an electric motor, electrical actuators are highly reliable and very easy to set up and operate. In addition, the latest generation of actuators offers many intelligent features. Modular accessories such as electric interfaces, integrated battery-powered fail-safe units and visual system feedback are also available.

Pneumatic actuator for reliable operation

The pneumatic actuators are suitable for a wide range of environments and guarantee high levels of safety and reliability thanks to their fail-safe operation, robust design and high functionality, such as fast cycle times and adjustable travel. They are an economical, functional and reliable solution, especially for installations with a high number of actuated valves.

Reduction gear with handwheel

The reduction gear with handwheel allows reliable, manual operation of the Butterfly Valve 565. Worm gears ensure that only minimal physical effort is required. They can fully open and close and are useful for high-stress situations.

Monitoring by the double sensor

The optional LED position feedback allows the current position of the valve to be centrally recorded and checked at any time – for manually operated and automated valves. The compact dual sensor fits even in the most tight areas and is protected against ingress of water and dust.

Information via Data-Matrix-Code

The Data-Matrix-Code simplifies the storage of all technical information for each individual valve and thus enables individual traceability. The faultless identification of each Butterfly Valve 565 facilitates easy installation, service and repair.

Find out more
www.gfps.com/565

Butterfly Valve 565

Product range



Butterfly Valve 565



Wafer-style, intermediate installation butterfly valve type 565 PVDF/PA-GF

Bare shaft

Flange standard metric/ANSI/BS/JIS

Suitable for ABS, PVC-U, PVC-C, ecoFIT and PROGEF Systems

Model:

- Installation length: EN558 row 20, ISO 5752 row 20, API 609 table 2
- Flange standards: ISO 7005 PN10/16, EN 1092 PN10/16, DIN 2501 PN10/16, ANSI/ASME B 16.5 Class 150, BS 1560: 1989 Class 125/150; BS 4504 PN10/16, JIS B 2220 10K, JIS B 2239 10K
- For easy installation and removal
- Suitable for water and water treatment applications (e.g. sea water, drinking water and industrial water)

Option:

- Individual configuration of the valve possible
- Hand (lockable), pneumatic or electric actuators from GF
- Double sensor for electrical position feedback incl. LED feedback

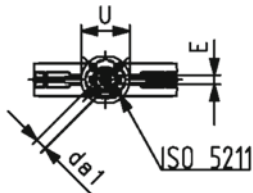
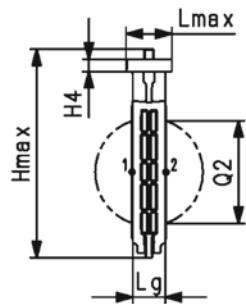
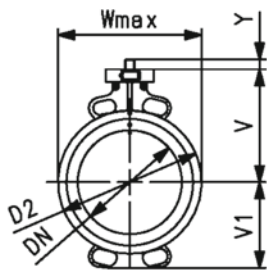

DN (mm)	PN (bar)	d (mm)	Size (inch)	kv-value ($\Delta p=1$ bar) (L/min)	Acc.to ISO 5211	EPDM Code	SP	Weight (kg)
50	16	63	2	1445	F07	199 565 100	1	0.9
65	16	75	2 ½	2530	F07	199 565 101	1	1.1
80	16	90	3	4020	F07	199 565 102	1	1.3
100	16	110	4	5850	F07	199 565 103	1	2.0
125	16	140	5	11900	F07	199 565 104	1	2.6
150	16	160	6	18050	F07	199 565 105	1	3.7
200	10	225	8	43667	F07	199 565 106	1	4.7
250	10	280	10		F10	199 565 107	1	8.8
300	6	315	12		F10	199 565 108	1	12.6

DN (mm)	FKM Code	SP	Weight (kg)
50	199 565 120	1	1.0
65	199 565 121	1	1.2
80	199 565 122	1	1.4
100	199 565 123	1	2.2
125	199 565 124	1	2.9
150	199 565 125	1	3.8
200	199 565 126	1	5.2
250	199 565 127	1	9.5
300	199 565 128	1	13.7

DN (mm)	D2 (mm)	Wmax (mm)	Lmax (mm)	Hmax (mm)	H4 (mm)	V (mm)	V1 (mm)	Lg (mm)	da1 (mm)	E (mm)	U (mm)	Y (mm)	Q2 (mm)
50	100.0	118.5	85.5	222.5	23.0	133.5	63.0	43.0	14.1	11.0	90.0	27.0	28.5
65	121.0	132.5	85.5	248.5	23.0	140.0	82.0	46.0	14.1	11.0	90.0	27.0	44.0
80	138.0	138.0	85.5	261.0	23.0	146.0	89.0	46.0	14.1	11.0	90.0	27.0	63.5
100	158.5	158.5	85.5	286.0	23.0	166.5	104.0	52.0	18.1	14.0	90.0	16.0	84.0
125	187.0	187.0	85.5	313.5	23.0	180.0	118.0	56.0	18.1	14.0	90.0	16.0	110.5
150	213.0	213.0	85.5	337.5	23.0	189.0	130.5	56.0	22.2	17.0	90.0	19.0	137.5
200	267.0	267.0	85.5	387.0	23.0	209.5	159.0	60.0	22.2	17.0	90.0	18.5	190.5
250	325.5	325.5	125.5	499.0	23.0	262.5	195.5	68.0	28.2	22.0	125.0	41.0	239.0
300	380.0	380.0	125.5	555.0	23.0	284.5	230.5	78.0	28.2	22.0	125.0	41.0	285.5



Wafer-style, intermediate installation butterfly valve type 565 PVDF/PA-GF
With hand lever
Flange standard metric/ANSI/BS/JIS
Suitable for ABS, PVC-U, PVC-C, ecoFIT and PROGEF Systems

Model:

- Installation length: EN558 row 20, ISO 5752 row 20, API 609 table 2
- Flange standards: ISO 7005 PN10/16, EN 1092 PN10/16, DIN 2501 PN10/16, ANSI/ASME B 16.5 Class 150, BS 1560: 1989 Class 125/150; BS 4504 PN10/16, JIS B 2220 10K, JIS B 2239 10K
- For easy installation and removal
- Lockable ergonomic lever
- Suitable for water and water treatment applications (e.g. sea water, drinking water and industrial water)

Option:

- Individual configuration of the valve possible
- Pneumatic or electric actuators from GF
- Double sensor for electrical position feedback incl. LED feedback

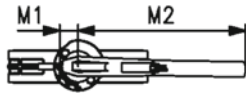
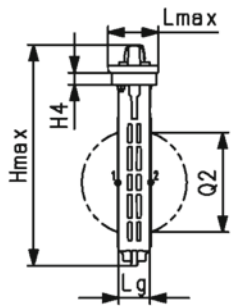
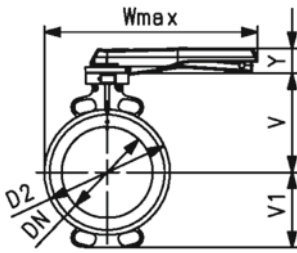

DN (mm)	PN (bar)	d (mm)	Size (inch)	kv-value ($\Delta p=1$ bar) (L/min)	EPDM Code	SP Weight (kg)	FKM Code	SP Weight (kg)
50	16	63	2	1445	199 565 000	1	1.3	199 565 020
65	16	75	2 ½	2530	199 565 001	1	1.5	199 565 021
80	16	90	3	4020	199 565 002	1	1.7	199 565 022
100	16	110	4	5850	199 565 003	1	2.5	199 565 023
125	16	140	5	11900	199 565 004	1	3.1	199 565 024
150	16	160	6	18050	199 565 005	1	4.0	199 565 025
200	10	225	8	43667	199 565 006	1	5.3	199 565 026

DN (mm)	D2 (mm)	Wmax (mm)	Hmax (mm)	Lmax (mm)	H4 (mm)	V (mm)	V1 (mm)	Lg (mm)	M1 (mm)	M2 (mm)	Y (mm)	Q2 (mm)
50	100.0	264.0	249.5	96.0	23.0	133.5	63.0	43.0	35.5	204.5	53.0	28.5
65	121.0	271.0	275.5	96.0	23.0	140.0	82.0	46.0	35.5	204.5	53.0	44.0
80	138.0	273.5	288.0	96.0	23.0	146.0	89.0	46.0	35.5	204.5	53.0	63.5
100	158.5	334.0	324.0	96.0	23.0	166.5	104.0	52.0	35.5	254.5	53.0	84.0
125	187.0	348.0	351.0	96.0	23.0	180.0	118.0	56.0	35.5	254.5	53.0	110.5
150	213.0	426.0	372.5	96.0	23.0	189.0	130.5	56.0	35.5	319.5	53.0	137.5
200	267.0	453.0	422.0	96.0	23.0	209.5	159.0	60.0	35.5	319.5	53.0	190.5



Wafer-style, intermediate installation butterfly valve type565 manual PVDF/PA-GF
With gear box
Wafer style metric/ANSI/BS/JIS
Suitable for ABS, PVC-U, PVC-C, ecoFIT and PROGEF Systems

Model:

- Installation length: EN558 row 20, ISO 5752 row 20, API 609 table 2
- Flange standards: ISO 7005 PN10/16, EN 1092 PN10/16, DIN 2501 PN10/16, ANSI/ASME B 16.5 Class 150, BS 1560: 1989 Class 125/150; BS 4504 PN10/16, JIS B 2220 10K, JIS B 2239 10K
- For easy installation and removal
- Suitable for water and water treatment applications (e.g. sea water, drinking water and industrial water)

Option:

- Individual configuration of the valve possible
- Hand (lockable hand lever), pneumatic or electric actuators from GF
- Double sensor for electrical position feedback incl. LED feedback

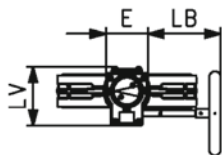
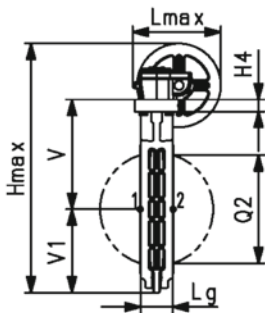
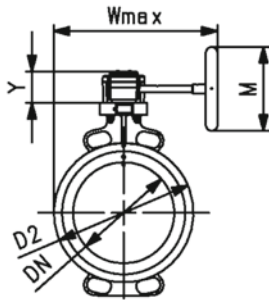

DN (mm)	PN (bar)	d (mm)	Size (inch)	kv-value ($\Delta p=1$ bar) (L/min)	EPDM Code	SP Weight (kg)	FKM Code	SP Weight (kg)
50	16	63	2	1445	199 565 200	1	3.0	199 565 220
65	16	75	2 ½	2530	199 565 201	1	3.2	199 565 221
80	16	90	3	4020	199 565 202	1	3.4	199 565 222
100	16	110	4	5850	199 565 203	1	4.2	199 565 223
125	16	140	5	11900	199 565 204	1	4.7	199 565 224
150	16	160	6	18050	199 565 205	1	5.5	199 565 225
200	10	225	8	43667	199 565 206	1	6.7	199 565 226
250	10	280	10		199 565 207	1	12.7	199 565 227
300	6	315	12		199 565 208	1	16.5	199 565 228

DN (mm)	D2 (mm)	Wmax (mm)	Hmax (mm)	Lmax (mm)	H4 (mm)	V (mm)	V1 (mm)	Lg (mm)	E (mm)	LB (mm)	LV (mm)	M (mm)	Y (mm)
50	100.0	238.5	303.0	169.0	23.0	133.5	63.0	43.0	80.0	128.0	112.5	160.0	61.5
65	121.0	246.0	329.0	169.0	23.0	140.0	82.0	46.0	80.0	128.0	112.5	160.0	61.5
80	138.0	248.5	341.5	169.0	23.0	146.0	89.0	46.0	80.0	128.0	112.5	160.0	61.5
100	158.5	258.5	377.5	169.0	23.0	166.5	104.0	52.0	80.0	128.0	112.5	160.0	61.5
125	187.0	272.0	405.0	169.0	23.0	180.0	118.0	56.0	80.0	128.0	112.5	160.0	61.5
150	213.0	285.5	426.5	169.0	23.0	189.0	130.5	56.0	80.0	128.0	112.5	160.0	61.5
200	267.0	312.5	475.5	169.0	23.0	209.5	159.0	60.0	80.0	128.0	112.5	160.0	61.5
250	325.5	360.5	603.0	212.5	23.0	262.5	195.5	68.0	100.0	135.5	130.0	200.0	68.5
300	380.0	387.5	659.5	212.5	23.0	284.5	230.5	78.0	100.0	135.5	130.0	200.0	68.5

DN (mm)	Q2 (mm)
50	28.5
65	44.0
80	63.5
100	84.0
125	110.5
150	137.5
200	190.5
250	239.0
300	285.5



Wafer-style, intermediate installation butterfly valve type 565 PVDF/PA-GF
With electric actuator 230V
Without manual override
Flange standard metric/ANSI/BS/JIS
Suitable for ABS, PVC-U, PVC-C, ecoFIT and PROGEF Systems

Model:

- Installation length: EN558 row 20, ISO 5752 row 20, API 609 table 2
- Flange standards: ISO 7005 PN10/16, EN 1092 PN10/16, DIN 2501 PN10/16, ANSI/ASME B 16.5 Class 150, BS 1560: 1989 Class 125/150; BS 4504 PN10/16, JIS B 2220 10K, JIS B 2239 10K
- For easy installation and removal
- Voltage 100-230V, 50-60Hz
- Factory set control range 0-90°
- Heating element, position feedback (Open/Close/ Middle)
- Manual override integrated in electric actuator
- Suitable for water and water treatment applications (e.g. sea water, drinking water and industrial water)

Option:

- Individual configuration of the valve possible
- Hand or pneumatic actuators from GF
- Double sensor for electrical position feedback incl. LED feedback
- Optional accessories: Fail-safe return unit, Monitoring board, Position controller, Profibus DP board
- Additional manual override between valve and actuator

Note:

***Preliminary data for DN250-300**

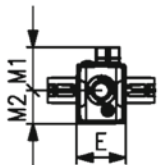
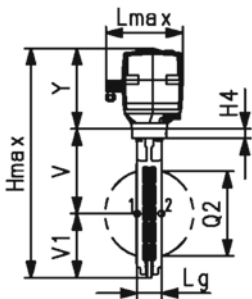

DN (mm)	PN (bar)	d (mm)	Size (inch)	kv-value (Δp=1 bar) (l/min)	Actuator	EPDM Code	SP	Weight (kg)
50	10	63	2	1445	EA45	199 565 300	1	3.3
65	10	75	2 ½	2530	EA120	199 565 301	1	4.6
80	10	90	3	4020	EA120	199 565 302	1	4.7
100	10	110	4	5850	EA120	199 565 303	1	5.6
125	10	140	5	11900	EA120	199 565 304	1	6.1
150	10	160	6	18050	EA250	199 565 305	1	8.7
200	10	225	8	43667	EA250	199 565 306	1	10.0
*	250	6	280		EA250	199 565 307	1	14.5
*	300	4	315		EA250	199 565 308	1	18.2

DN (mm)	FKM Code	SP	Weight (kg)
50	199 565 320	1	3.4
65	199 565 321	1	4.7
80	199 565 322	1	4.8
100	199 565 323	1	5.8
125	199 565 324	1	6.4
150	199 565 325	1	9.0
200	199 565 326	1	10.5
*	250	199 565 327	15.2
*	300	199 565 328	19.4

DN (mm)	D2 (mm)	Wmax (mm)	Hmax (mm)	Lmax (mm)	H4 (mm)	V (mm)	V1 (mm)	Lg (mm)	E (mm)	M1 (mm)	M2 (mm)	Y (mm)
50	100.0	122.5	377.5	190.0	23.0	133.5	63.0	43.0	122.5	107.5	83.0	166.5
65	121.0	132.5	411.5	190.0	23.0	140.0	82.0	46.0	122.5	107.5	83.0	189.5
80	138.0	137.5	424.0	190.0	23.0	146.0	89.0	46.0	122.5	107.5	83.0	189.5
100	158.5	158.5	459.5	190.0	23.0	166.5	104.0	52.0	122.5	107.5	83.0	189.5
125	187.0	187.0	487.5	190.0	23.0	180.0	118.0	56.0	122.5	107.5	83.0	189.5
150	213.0	213.0	518.5	190.0	23.0	189.0	130.5	56.0	122.5	107.5	83.0	199.5
200	267.0	267.0	568.0	190.0	23.0	209.5	159.0	60.0	122.5	107.5	83.0	199.5
*	250	325.5	674.5	190.0	23.0	262.5	195.5	68.0	122.5	107.5	83.0	216.5
*	300	380.0	731.0	190.0	23.0	284.5	230.5	78.0	122.5	107.5	83.0	216.5

table continued on the next page

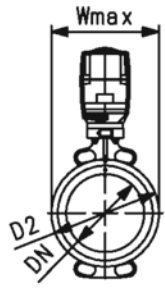

	DN (mm)	Q2 (mm)
	50	28.5
	65	44.0
	80	63.5
	100	84.0
	125	110.5
	150	137.5
	200	190.5
	* 250	239.0
	* 300	285.5

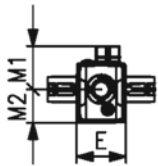
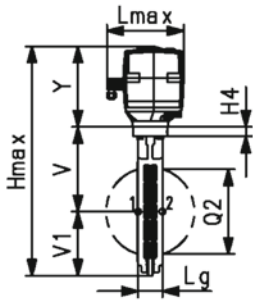



Wafer-style, intermediate installation butterfly valve type 565 PVDF/PA-GF
With electric actuator 24V
Without manual override
Wafer style metric/ANSI/BS/JIS
Suitable for ABS, PVC-U, PVC-C, ecoFIT and PROGEF Systems

Model:

- Installation length: EN558 row 20, ISO 5752 row 20, API 609 table 2
- Flange standards: ISO 7005 PN10/16, EN 1092 PN10/16, DIN 2501 PN10/16, ANSI/ASME B 16.5 Class 150, BS 1560: 1989 Class 125/150; BS 4504 PN10/16, JIS B 2220 10K, JIS B 2239 10K
- For easy installation and removal
- Voltage 24V AC/DC
- Factory set control range 0-90°
- Heating element, position feedback (Open/Close/ Middle)
- Manual override integrated in electric actuator
- Suitable for water and water treatment applications (e.g. sea water, drinking water and industrial water)

Option:

- Individual configuration of the valve possible
- Hand or pneumatic actuators from GF
- Double sensor for electrical position feedback incl. LED feedback
- Optional accessories: Fail-safe return unit, Monitoring board, Position controller, Profibus DP board
- Additional manual override between valve and actuator

Note:

***Preliminary data for DN250-300**

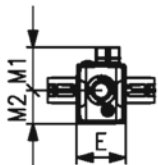
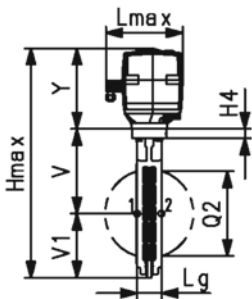
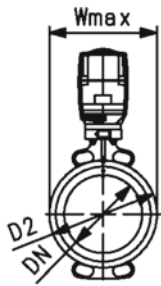

DN (mm)	PN (bar)	d (mm)	Size (inch)	kv-value (Δp=1 bar) (l/min)	Actuator	EPDM Code	SP	Weight (kg)
50	10	63	2	1445	EA45	199 565 400	1	3.3
65	10	75	2 ½	2530	EA120	199 565 401	1	4.6
80	10	90	3	4020	EA120	199 565 402	1	4.7
100	10	110	4	5850	EA120	199 565 403	1	5.6
125	10	140	5	11900	EA120	199 565 404	1	6.1
150	10	160	6	18050	EA250	199 565 405	1	8.7
200	10	225	8	43667	EA250	199 565 406	1	10.0
*	250	6	280		EA250	199 565 407	1	14.5
*	300	4	315		EA250	199 565 408	1	18.2

DN (mm)	FKM Code	SP	Weight (kg)
50	199 565 420	1	3.4
65	199 565 421	1	4.7
80	199 565 422	1	4.8
100	199 565 423	1	5.8
125	199 565 424	1	6.4
150	199 565 425	1	9.0
200	199 565 426	1	10.5
*	250	199 565 427	15.2
*	300	199 565 428	19.4

DN (mm)	D2 (mm)	Wmax (mm)	Hmax (mm)	Lmax (mm)	H4 (mm)	V (mm)	V1 (mm)	Lg (mm)	E (mm)	M1 (mm)	M2 (mm)	Y (mm)
50	100.0	122.5	377.5	190.0	23.0	133.5	63.0	43.0	122.5	107.5	83.0	166.5
65	121.0	132.5	411.5	190.0	23.0	140.0	82.0	46.0	122.5	107.5	83.0	189.5
80	138.0	137.5	424.0	190.0	23.0	146.0	89.0	46.0	122.5	107.5	83.0	189.5
100	158.5	158.5	459.5	190.0	23.0	166.5	104.0	52.0	122.5	107.5	83.0	189.5
125	187.0	187.0	487.5	190.0	23.0	180.0	118.0	56.0	122.5	107.5	83.0	189.5
150	213.0	213.0	518.5	190.0	23.0	189.0	130.5	56.0	122.5	107.5	83.0	199.5
200	267.0	267.0	568.0	190.0	23.0	209.5	159.0	60.0	122.5	107.5	83.0	199.5
*	250	325.5	674.5	190.0	23.0	262.5	195.5	68.0	122.5	107.5	83.0	216.5
*	300	380.0	731.0	190.0	23.0	284.5	230.5	78.0	122.5	107.5	83.0	216.5

table continued on the next page

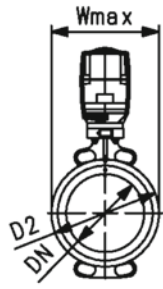

	DN (mm)	Q2 (mm)
	50	28.5
	65	44.0
	80	63.5
	100	84.0
	125	110.5
	150	137.5
	200	190.5
	* 250	239.0
	* 300	285.5

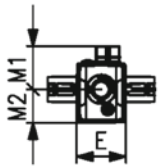
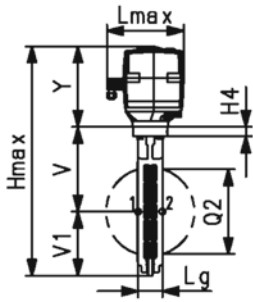



Wafer-style, intermediate installation butterfly valve type 565 PVDF/PA-GF
Smart electric actuator 230V
Without manual override
Wafer style metric/ANSI/BS/JIS
Suitable for ABS, PVC-U, PVC-C, ecoFIT and PROGEF Systems

Model:

- Installation length: EN558 row 20, ISO 5752 row 20, API 609 table 2
- Flange standards: ISO 7005 PN10/16, EN 1092 PN10/16, DIN 2501 PN10/16, ANSI/ASME B 16.5 Class 150, BS 1560: 1989 Class 125/150; BS 4504 PN10/16, JIS B 2220 10K, JIS B 2239 10K
- For easy installation and removal
- Voltage 100-230V, 50-60Hz
- Factory set control range 0-90°
- Heating element, position feedback (Open/Close/ Middle)
- Connectivity via NFC and Wi-Fi Direct ensuring control, identification and visibility without opening the case
- Most relevant asset data visualized in the app
- Connection and control via app possible
- LED stripe for visual open/close 360° feedback
- Manual override integrated in electric actuator
- Suitable for water and water treatment applications (e.g. sea water, drinking water and industrial water)

Option:

- Individual configuration of the valve possible
- Hand or pneumatic actuators from GF
- Double sensor for electrical position feedback incl. LED feedback
- Optional accessories: Fail-safe return unit, Monitoring board, Position controller, Profibus DP board
- Additional manual override between valve and actuator

Note:

***Preliminary data for DN250-300**

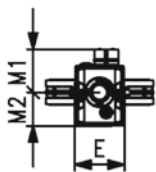
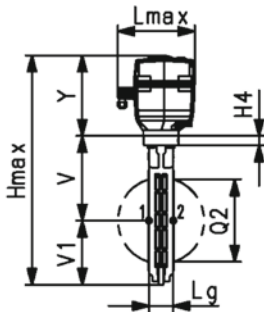
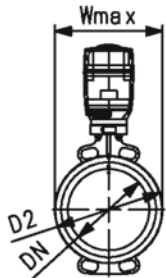

DN (mm)	PN (bar)	d (mm)	Size (inch)	kv-value (Δp=1 bar) (l/min)	Actuator	EPDM Code	SP	Weight (kg)
50	10	63	2	1445	dEA45	199 565 700	1	3.3
65	10	75	2 ½	2530	dEA120	199 565 701	1	4.6
80	10	90	3	4020	dEA120	199 565 702	1	4.7
100	10	110	4	5850	dEA120	199 565 703	1	5.6
125	10	140	5	11900	dEA120	199 565 704	1	6.1
150	10	160	6	18050	dEA250	199 565 705	1	8.7
200	10	225	8	43667	dEA250	199 565 706	1	10.0
*	250	6	280		dEA250	199 565 707	1	14.5
*	300	4	315		dEA250	199 565 708	1	18.2

DN (mm)	FKM Code	SP	Weight (kg)
50	199 565 709	1	3.4
65	199 565 710	1	4.7
80	199 565 711	1	4.8
100	199 565 712	1	5.8
125	199 565 713	1	6.4
150	199 565 714	1	9.0
200	199 565 715	1	10.5
*	199 565 716	1	15.2
*	199 565 717	1	19.4

DN (mm)	D2 (mm)	Wmax (mm)	Hmax (mm)	Lmax (mm)	H4 (mm)	V (mm)	V1 (mm)	Lg (mm)	E (mm)	M1 (mm)	M2 (mm)	Y (mm)
50	100.0	122.5	377.5	190.0	23.0	133.5	63.0	43.0	122.5	107.5	83.0	166.5
65	121.0	132.5	411.5	190.0	23.0	140.0	82.0	46.0	122.5	107.5	83.0	189.5
80	138.0	137.5	424.0	190.0	23.0	146.0	89.0	46.0	122.5	107.5	83.0	189.5
100	158.5	158.5	459.5	190.0	23.0	166.5	104.0	52.0	122.5	107.5	83.0	189.5
125	187.0	187.0	487.5	190.0	23.0	180.0	118.0	56.0	122.5	107.5	83.0	189.5

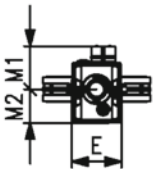
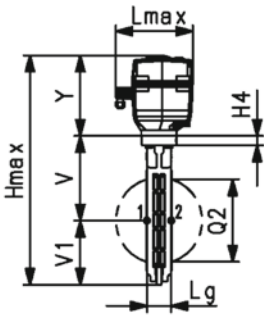
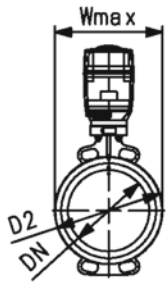

	DN (mm)	D2 (mm)	Wmax (mm)	Hmax (mm)	Lmax (mm)	H4 (mm)	V (mm)	V1 (mm)	Lg (mm)	E (mm)	M1 (mm)	M2 (mm)	Y (mm)
	150	213.0	213.0	518.5	190.0	23.0	189.0	130.5	56.0	122.5	107.5	83.0	199.5
	200	267.0	267.0	568.0	190.0	23.0	209.5	159.0	60.0	122.5	107.5	83.0	199.5
*	250	325.5	325.5	674.5	190.0	23.0	262.5	195.5	68.0	122.5	107.5	83.0	216.5
*	300	380.0	380.0	731.0	190.0	23.0	284.5	230.5	78.0	122.5	107.5	83.0	216.5

	DN (mm)	Q2 (mm)
	50	28.5
	65	44.0
	80	63.5
	100	84.0
	125	110.5
	150	137.5
	200	190.5
*	250	239.0
*	300	285.5

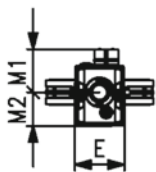
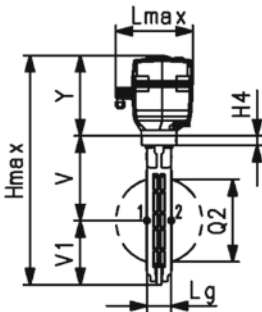
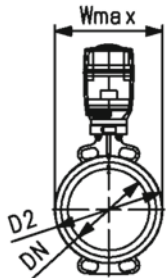

Wafer-style, intermediate installation butterfly valve type565 electric PVDF/PA-GF
Smart electric actuator 24V without manual override
Wafer style metric/ANSI/BS/JIS
Suitable for ABS, PVC-U, PVC-C, ecoFIT and PROGEF Systems

Model:

- Installation length: EN558 row 20, ISO 5752 row 20, API 609 table 2
- Flange standards: ISO 7005 PN10/16, EN 1092 PN10/16, DIN 2501 PN10/16, ANSI/ASME B 16.5 Class 150, BS 1560: 1989 Class 125/150; BS 4504 PN10/16, JIS B 2220 10K, JIS B 2239 10K
- For easy installation and removal
- Voltage 24V AC/DC
- Factory set control range 0-90°
- Heating element, position feedback (Open/Close/ Middle)
- Connectivity via NFC and Wi-Fi Direct ensuring control, identification and visibility without opening the case
- Most relevant asset data visualized in the app
- Connection and control via app possible
- LED stripe for visual open/close 360° feedback
- Manual override integrated in electric actuator
- Suitable for water and water treatment applications (e.g. sea water, drinking water and industrial water)

Option:

- Individual configuration of the valve possible
- Hand or pneumatic actuators from GF
- Double sensor for electrical position feedback incl. LED feedback
- Optional accessories: Fail-safe return unit, Monitoring board, Position controller, Profibus DP board
- Additional manual override between valve and actuator

Note:

***Preliminary data for DN250-300**

DN (mm)	PN (bar)	d (mm)	Size (inch)	kv-value ($\Delta p=1$ bar) (L/min)	Actuator	EPDM Code	SP	Weight (kg)
50	10	63	2	1445	dEA45	199 565 718	1	3.3
65	10	75	2 ½	2530	dEA120	199 565 719	1	4.6
80	10	90	3	4020	dEA120	199 565 720	1	4.7
100	10	110	4	5850	dEA120	199 565 721	1	5.6
125	10	140	5	11900	dEA120	199 565 722	1	6.1
150	10	160	6	18050	dEA250	199 565 723	1	8.7
200	10	225	8	43667	dEA250	199 565 724	1	10.0
* 250	6	280	10		dEA250	199 565 725	1	14.5
* 300	4	315	12		dEA250	199 565 726	1	18.2

DN (mm)	FKM Code	SP	Weight (kg)
50	199 565 727	1	3.4
65	199 565 728	1	4.7
80	199 565 729	1	4.8
100	199 565 730	1	5.8
125	199 565 731	1	6.4
150	199 565 732	1	9.0
200	199 565 733	1	10.5
* 250	199 565 734	1	15.2
* 300	199 565 735	1	19.4

DN (mm)	D2 (mm)	Wmax (mm)	Hmax (mm)	Lmax (mm)	H4 (mm)	V (mm)	V1 (mm)	Lg (mm)	E (mm)	M1 (mm)	M2 (mm)	Y (mm)
50	100.0	122.5	377.5	190.0	23.0	133.5	63.0	43.0	122.5	107.5	83.0	166.5
65	121.0	132.5	411.5	190.0	23.0	140.0	82.0	46.0	122.5	107.5	83.0	189.5
80	138.0	137.5	424.0	190.0	23.0	146.0	89.0	46.0	122.5	107.5	83.0	189.5
100	158.5	158.5	459.5	190.0	23.0	166.5	104.0	52.0	122.5	107.5	83.0	189.5
125	187.0	187.0	487.5	190.0	23.0	180.0	118.0	56.0	122.5	107.5	83.0	189.5

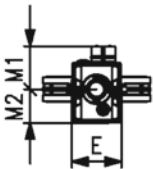
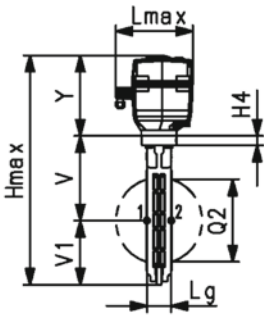
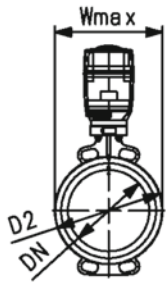

	DN (mm)	D2 (mm)	Wmax (mm)	Hmax (mm)	Lmax (mm)	H4 (mm)	V (mm)	V1 (mm)	Lg (mm)	E (mm)	M1 (mm)	M2 (mm)	Y (mm)
	150	213.0	213.0	518.5	190.0	23.0	189.0	130.5	56.0	122.5	107.5	83.0	199.5
	200	267.0	267.0	568.0	190.0	23.0	209.5	159.0	60.0	122.5	107.5	83.0	199.5
*	250	325.5	325.5	674.5	190.0	23.0	262.5	195.5	68.0	122.5	107.5	83.0	216.5
*	300	380.0	380.0	731.0	190.0	23.0	284.5	230.5	78.0	122.5	107.5	83.0	216.5

	DN (mm)	Q2 (mm)
	50	28.5
	65	44.0
	80	63.5
	100	84.0
	125	110.5
	150	137.5
	200	190.5
*	250	239.0
*	300	285.5



Wafer-style, intermediate installation butterfly valve type 565 PVDF/PA-GF
With electric actuator 230V
With manual override
Flange standard metric/ANSI/BS/JIS
Suitable for ABS, PVC-U, PVC-C, ecoFIT and PROGEF Systems

Model:

- Installation length: EN558 row 20, ISO 5752 row 20, API 609 table 2
- Flange standards: ISO 7005 PN10/16, EN 1092 PN10/16, DIN 2501 PN10/16, ANSI/ASME B 16.5 Class 150, BS 1560: 1989 Class 125/150; BS 4504 PN10/16, JIS B 2220 10K, JIS B 2239 10K
- For easy installation and removal
- Voltage 100-230V, 50-60Hz
- Factory set control range 0-90°
- Heating element, position feedback (Open/Close/ Middle)
- With additional manual override between valve and actuator
- Suitable for water and water treatment applications (e.g. sea water, drinking water and industrial water)

Option:

- Individual configuration of the valve possible
- Hand or pneumatic actuators from GF
- Double sensor for electrical position feedback incl. LED feedback
- Optional accessories: Fail-safe return unit, Monitoring board, Position controller, Profibus DP board

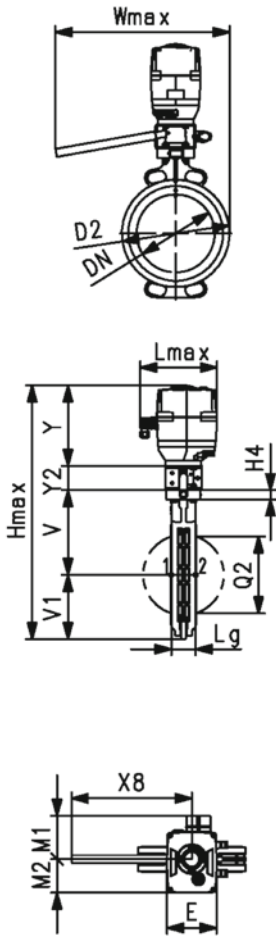

DN (mm)	PN (bar)	d (mm)	Size (inch)	kv-value ($\Delta p=1$ bar) (L/min)	Actuator	EPDM Code	SP	Weight (kg)
50	10	63	2	1445	EA120	199 565 340	1	5.5
65	10	75	2 ½	2530	EA120	199 565 341	1	5.8
80	10	90	3	4020	EA120	199 565 342	1	5.9
100	10	110	4	5850	EA120	199 565 343	1	6.6
125	10	140	5	11900	EA120	199 565 344	1	7.1
150	10	160	6	18050	EA250	199 565 345	1	9.7
200	10	225	8	43667	EA250	199 565 346	1	11.0

DN (mm)	FKM Code	SP	Weight (kg)
50	199 565 360	1	5.6
65	199 565 361	1	5.9
80	199 565 362	1	6.0
100	199 565 363	1	6.8
125	199 565 364	1	7.4
150	199 565 365	1	10.0
200	199 565 366	1	11.5

DN (mm)	D2 (mm)	Wmax (mm)	Hmax (mm)	Lmax (mm)	H4 (mm)	V (mm)	V1 (mm)	Lg (mm)	E (mm)	M1 (mm)	M2 (mm)	X8 (mm)	Y (mm)
50	100.0	385.5	96.0	190.0	23.0	133.5	63.0	43.0	122.5	107.5	83.0	297.5	189.5
65	121.0	385.5	96.0	190.0	23.0	140.0	82.0	46.0	122.5	107.5	83.0	297.5	189.5
80	138.0	385.5	96.0	190.0	23.0	146.0	89.0	46.0	122.5	107.5	83.0	297.5	189.5
100	158.5	385.5	96.0	190.0	23.0	166.5	104.0	52.0	122.5	107.5	83.0	297.5	189.5
125	187.0	385.5	189.5	190.0	23.0	180.0	118.0	56.0	122.5	107.5	83.0	297.5	189.5
150	213.0	385.5	106.0	190.0	23.0	189.0	130.5	56.0	122.5	107.5	83.0	297.5	199.5
200	267.0	385.5	106.0	190.0	23.0	209.5	159.0	60.0	122.5	107.5	83.0	297.5	199.5

DN (mm)	Y2 (mm)	Q2 (mm)
50	60.0	28.5
65	60.0	44.0
80	60.0	63.5
100	60.0	84.0
125	60.0	110.5
150	60.0	137.5
200	60.0	190.5



Wafer-style, intermediate installation butterfly valve type 565 PVDF/PA-GF
With electric actuator 24V
With manual override
Wafer style metric/ANSI/BS/JIS
Suitable for ABS, PVC-U, PVC-C, ecoFIT and PROGEF Systems

Model:

- Installation length: EN558 row 20, ISO 5752 row 20, API 609 table 2
- Flange standards: ISO 7005 PN10/16, EN 1092 PN10/16, DIN 2501 PN10/16, ANSI/ASME B 16.5 Class 150, BS 1560: 1989 Class 125/150; BS 4504 PN10/16, JIS B 2220 10K, JIS B 2239 10K
- For easy installation and removal
- Voltage 24V AC/DC
- Factory set control range 0-90°
- Heating element, position feedback (Open/Close/ Middle)
- Manual override integrated in electric actuator
- With additional manual override between valve and actuator
- Suitable for water and water treatment applications (e.g. sea water, drinking water and industrial water)

Option:

- Individual configuration of the valve possible
- Hand or pneumatic actuators from GF
- Double sensor for electrical position feedback incl. LED feedback
- Optional accessories: Fail-safe return unit, Monitoring board, Position controller, Profibus DP board

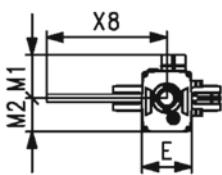
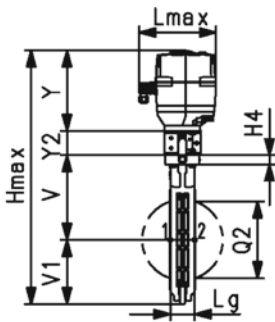
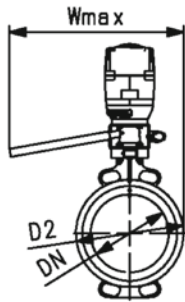

DN (mm)	PN (bar)	d (mm)	Size (inch)	kv-value ($\Delta p=1$ bar) (L/min)	Actuator	EPDM Code	SP	Weight (kg)
50	10	63	2	1445	EA120	199 565 440	1	5.5
65	10	75	2 ½	2530	EA120	199 565 441	1	5.8
80	10	90	3	4020	EA120	199 565 442	1	5.9
100	10	110	4	5850	EA120	199 565 443	1	6.6
125	10	140	5	11900	EA120	199 565 444	1	7.1
150	10	160	6	18050	EA250	199 565 445	1	9.7
200	10	225	8	43667	EA250	199 565 446	1	11.0

DN (mm)	FKM Code	SP	Weight (kg)
50	199 565 460	1	5.6
65	199 565 461	1	5.9
80	199 565 462	1	6.0
100	199 565 463	1	6.8
125	199 565 464	1	7.4
150	199 565 465	1	10.0
200	199 565 466	1	11.5

DN (mm)	D2 (mm)	Wmax (mm)	Hmax (mm)	Lmax (mm)	H4 (mm)	V (mm)	V1 (mm)	Lg (mm)	E (mm)	M1 (mm)	M2 (mm)	X8 (mm)	Y (mm)
50	100.0	385.5	96.0	190.0	23.0	133.5	63.0	43.0	122.5	107.5	83.0	297.5	189.5
65	121.0	385.5	96.0	190.0	23.0	140.0	82.0	46.0	122.5	107.5	83.0	297.5	189.5
80	138.0	385.5	96.0	190.0	23.0	146.0	89.0	46.0	122.5	107.5	83.0	297.5	189.5
100	158.5	385.5	96.0	190.0	23.0	166.5	104.0	52.0	122.5	107.5	83.0	297.5	189.5
125	187.0	385.5	189.5	190.0	23.0	180.0	118.0	56.0	122.5	107.5	83.0	297.5	189.5
150	213.0	385.5	106.0	190.0	23.0	189.0	130.5	56.0	122.5	107.5	83.0	297.5	199.5
200	267.0	385.5	106.0	190.0	23.0	209.5	159.0	60.0	122.5	107.5	83.0	297.5	199.5

DN (mm)	Y2 (mm)	Q2 (mm)
50	60.0	28.5
65	60.0	44.0
80	60.0	63.5
100	60.0	84.0
125	60.0	110.5
150	60.0	137.5
200	60.0	190.5



Wafer-style, intermediate installation butterfly valve type 565 PVDF/PA-GF
With pneumatic actuator - fail safe to close (FC)
Wafer style metric/ANSI/BS/JIS
Suitable for ABS, PVC-U, PVC-C, ecoFIT and PROGEF Systems

Model:

- Installation length: EN558 row 20, ISO 5752 row 20, API 609 table 2
- Flange standards: ISO 7005 PN10/16, EN 1092 PN10/16, DIN 2501 PN10/16, ANSI/ASME B 16.5 Class 150, BS 1560: 1989 Class 125/150; BS 4504 PN10/16, JIS B 2220 10K, JIS B 2239 10K
- For easy installation and removal
- Control time 0-90° 1-2s
- Suitable for water and water treatment applications (e.g. sea water, drinking water and industrial water)

Option:

- Individual configuration of the valve possible
- Hand or electric actuators from GF
- Double sensor for electrical position feedback incl. LED feedback

Note:

*Preliminary data for DN250-300

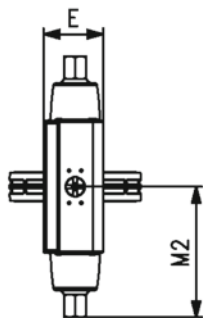
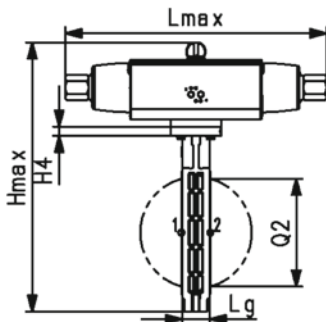
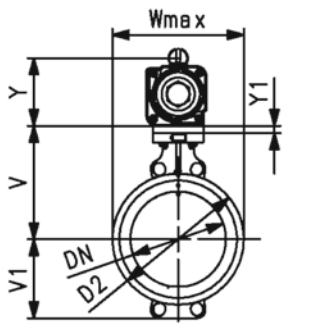

DN (mm)	PN (bar)	d (mm)	Size (inch)	kv-value ($\Delta p=1$ bar) (L/min)	Actuator	EPDM Code	SP	Weight (kg)
50	10	63	2	1445	PA30	199 565 500	1	3.2
65	10	75	2 ½	2530	PA30	199 565 501	1	3.5
80	10	90	3	4020	PA35	199 565 502	1	4.3
100	10	110	4	5850	PA40	199 565 503	1	5.9
125	10	140	5	11900	PA45	199 565 504	1	7.9
150	10	160	6	18050	PA50	199 565 505	1	10.7
200	10	225	8	43667	PA60	199 565 506	1	16.4
* 250	10	280	10		PA65	199 565 507	1	25.5
* 300	6	315	12		PA70	199 565 508	1	32.1

DN (mm)	FKM Code	SP	Weight (kg)
50	199 565 520	1	3.3
65	199 565 521	1	3.6
80	199 565 522	1	4.4
100	199 565 523	1	6.1
125	199 565 524	1	8.2
150	199 565 525	1	11.0
200	199 565 526	1	16.9
* 250	199 565 527	1	26.2
* 300	199 565 528	1	33.3

DN (mm)	D2 (mm)	Wmax (mm)	Hmax (mm)	Lmax (mm)	H4 (mm)	V (mm)	V1 (mm)	Lg (mm)	E (mm)	M2 (mm)	Y (mm)	Y1 (mm)
50	100.0	118.5	309.5	274.5	23.0	133.5	63.0	43.0	70.5	137.2	98.5	15.0
65	121.0	132.5	335.5	275.5	23.0	140.0	82.0	46.0	70.5	137.2	98.5	15.0
80	138.0	138.0	361.0	325.5	23.0	146.0	89.0	46.0	83.5	162.6	111.5	15.0
100	158.5	158.5	385.5	359.5	23.0	166.5	104.0	52.0	87.0	179.8	115.0	0.0
125	187.0	187.0	447.5	418.0	23.0	180.0	118.0	56.0	107.5	209.0	149.5	0.0
150	213.0	213.0	472.5	434.0	23.0	189.0	130.5	56.0	111.5	217.0	153.5	0.0
200	267.0	267.0	545.5	547.5	23.0	209.5	159.0	60.0	135.0	273.6	177.0	0.0
* 250	325.5	325.5	666.0	681.0	23.0	262.5	195.5	68.0	148.0	323.0	190.0	18.0
* 300	380.0	380.0	742.5	681.0	23.0	284.5	230.5	78.0	168.0	340.5	210.5	18.0

DN (mm)	Q2 (mm)
50	28.5
65	44.0
80	63.5
100	84.0
125	110.5

table continued on the next page

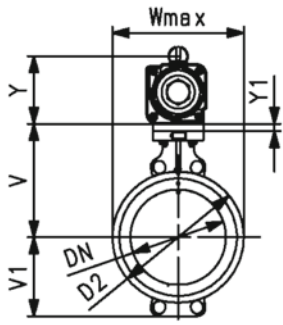

	DN (mm)	Q2 (mm)
	150	137.5
	200	190.5
*	250	239.0
*	300	285.5

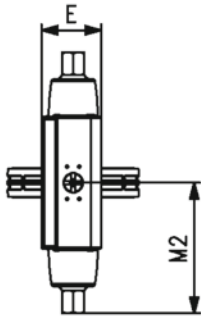
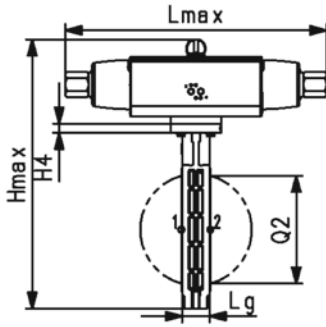



Wafer-style, intermediate installation butterfly valve type 565 PVDF/PA-GF
With pneumatic actuator - fail safe to open (FO)
Wafer style metric/ANSI/BS/JIS
Suitable for ABS, PVC-U, PVC-C, ecoFIT and PROGEF Systems

Model:

- Installation length: EN558 row 20, ISO 5752 row 20, API 609 table 2
- Flange standards: ISO 7005 PN10/16, EN 1092 PN10/16, DIN 2501 PN10/16, ANSI/ASME B 16.5 Class 150, BS 1560: 1989 Class 125/150; BS 4504 PN10/16, JIS B 2220 10K, JIS B 2239 10K
- For easy installation and removal
- Control time 0-90° 1-2s
- Suitable for water and water treatment applications (e.g. sea water, drinking water and industrial water)

Option:

- Individual configuration of the valve possible
- Hand or electric actuators from GF
- Double sensor for electrical position feedback incl. LED feedback

Note:

***Preliminary data for DN250-300**

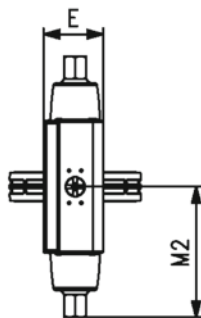
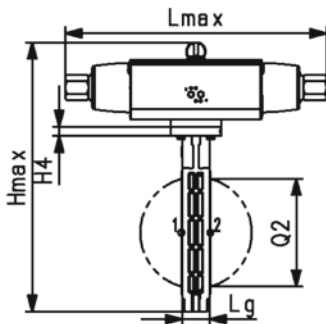
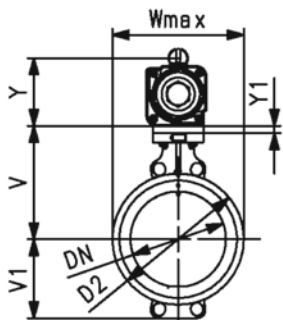

DN (mm)	PN (bar)	d (mm)	Size (inch)	kv-value ($\Delta p=1$ bar) (L/min)	Actuator	EPDM Code	SP	Weight (kg)
50	10	63	2	1445	PA30	199 565 540	1	3.2
65	10	75	2 ½	2530	PA30	199 565 541	1	3.5
80	10	90	3	4020	PA35	199 565 542	1	4.3
100	10	110	4	5850	PA40	199 565 543	1	5.9
125	10	140	5	11900	PA45	199 565 544	1	7.9
150	10	160	6	18050	PA50	199 565 545	1	10.7
200	10	225	8	43667	PA60	199 565 546	1	16.4
*	250	10	280		PA65	199 565 547	1	25.5
*	300	6	315	12	PA70	199 565 548	1	32.1

DN (mm)	FKM Code	SP	Weight (kg)
50	199 565 560	1	3.3
65	199 565 561	1	3.6
80	199 565 562	1	4.4
100	199 565 563	1	6.1
125	199 565 564	1	8.2
150	199 565 565	1	11.0
200	199 565 566	1	16.9
*	199 565 567	1	26.2
*	199 565 568	1	33.3

DN (mm)	D2 (mm)	Wmax (mm)	Hmax (mm)	Lmax (mm)	H4 (mm)	V (mm)	V1 (mm)	Lg (mm)	E (mm)	M2 (mm)	Y (mm)	Y1 (mm)
50	100.0	118.5	309.5	274.5	23.0	133.5	63.0	43.0	70.5	137.5	98.5	15.0
65	121.0	132.5	335.5	275.5	23.0	140.0	82.0	46.0	70.5	137.5	98.5	15.0
80	138.0	138.0	361.0	325.5	23.0	146.0	89.0	46.0	83.5	163.0	111.5	15.0
100	158.5	158.5	385.5	359.5	23.0	166.5	104.0	52.0	87.0	180.0	115.0	0.0
125	187.0	187.0	447.5	418.0	23.0	180.0	118.0	56.0	107.5	209.0	149.5	0.0
150	213.0	213.0	472.5	434.0	23.0	189.0	130.5	56.0	111.5	217.0	153.5	0.0
200	267.0	267.0	545.5	547.5	23.0	209.5	159.0	60.0	135.0	274.0	177.0	0.0
*	250	325.5	666.0	681.0	23.0	262.5	195.5	68.0	148.0	323.0	190.0	18.0
*	300	380.0	742.5	681.0	23.0	284.5	230.5	78.0	168.0	340.5	210.5	18.0

DN (mm)	Q2 (mm)
50	28.5
65	44.0
80	63.5
100	84.0
125	110.5

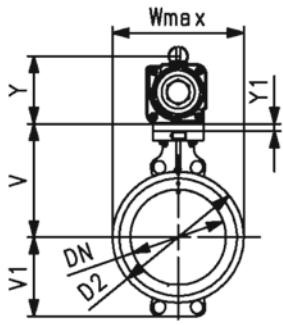

	DN (mm)	Q2 (mm)
	150	137.5
	200	190.5
*	250	239.0
*	300	285.5

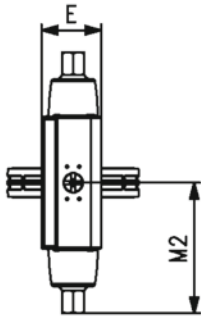
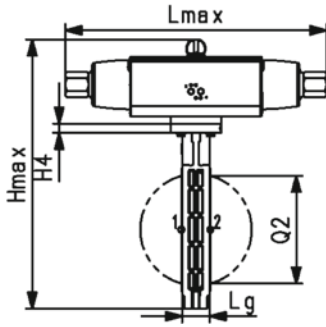



Wafer-style, intermediate installation butterfly valve type 565 PVDF/PA-GF
With pneumatic actuator - double acting (DA)
Wafer style metric/ANSI/BS/JIS
Suitable for ABS, PVC-U, PVC-C, ecoFIT and PROGEF Systems

Model:

- Installation length: EN558 row 20, ISO 5752 row 20, API 609 table 2
- Flange standards: ISO 7005 PN10/16, EN 1092 PN10/16, DIN 2501 PN10/16, ANSI/ASME B 16.5 Class 150, BS 1560: 1989 Class 125/150; BS 4504 PN10/16, JIS B 2220 10K, JIS B 2239 10K
- For easy installation and removal
- Control time 0-90° 1-2s
- Suitable for water and water treatment applications (e.g. sea water, drinking water and industrial water)

Option:

- Individual configuration of the valve possible
- Hand or electric actuators from GF
- Double sensor for electrical position feedback incl. LED feedback

Note:

***Preliminary data for DN250-300**

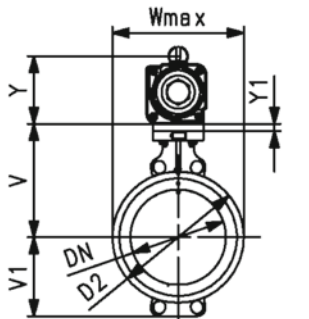

DN (mm)	PN (bar)	d (mm)	Size (inch)	kv-value (Δp=1 bar) (L/min)	Actuator	EPDM Code	SP	Weight (kg)
50	10	63	2	1445	PA35	199 565 600	1	2.6
65	10	75	2 ½	2530	PA35	199 565 601	1	2.9
80	10	90	3	4020	PA40	199 565 602	1	3.4
100	10	110	4	5850	PA45	199 565 603	1	4.5
125	10	140	5	11900	PA45	199 565 604	1	5.1
150	10	160	6	18050	PA55	199 565 605	1	7.7
200	10	225	8	43667	PA60	199 565 606	1	10.7
*	250	10	280		PA65	199 565 607	1	16.9
*	300	6	315	12	PA70	199 565 608	1	22.4

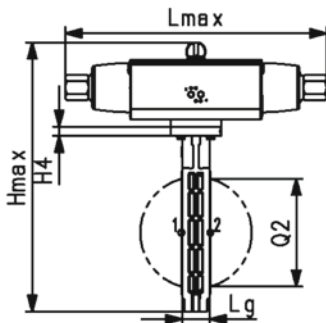

DN (mm)	FKM Code	SP	Weight (kg)
50	199 565 620	1	2.7
65	199 565 621	1	3.0
80	199 565 622	1	3.5
100	199 565 623	1	4.7
125	199 565 624	1	5.4
150	199 565 625	1	8.0
200	199 565 626	1	11.2
*	199 565 627	1	17.6
*	199 565 628	1	23.6

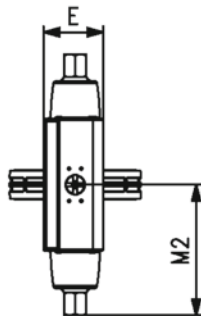

DN (mm)	D2 (mm)	Wmax (mm)	Hmax (mm)	Lmax (mm)	H4 (mm)	V (mm)	V1 (mm)	Lg (mm)	E (mm)	M2 (mm)	Y (mm)	Y1 (mm)
50	100.0	118.5	303.5	196.5	23.0	133.5	63.0	43.0	64.5	98.5	92.5	15.0
65	121.0	132.5	329.5	196.5	23.0	140.0	82.0	46.0	64.5	98.5	92.5	15.0
80	138.0	138.0	348.0	206.0	23.0	146.0	89.0	46.0	70.5	103.0	98.5	15.0
100	158.5	158.5	381.5	242.0	23.0	166.5	104.0	52.0	83.5	121.0	111.5	0.0
125	187.0	187.0	409.0	242.0	23.0	180.0	118.0	56.0	83.5	121.0	111.5	0.0
150	213.0	213.0	468.5	290.5	23.0	189.0	130.5	56.0	107.5	145.5	149.5	0.0
200	267.0	267.0	522.0	314.0	23.0	209.5	159.0	60.0	111.5	157.0	153.5	0.0
*	250	325.5	325.5	636.0	340.0	23.0	262.5	195.5	68.0	118.0	160.0	18.0
*	300	380.0	380.0	709.5	382.5	23.0	284.5	230.5	78.0	135.0	177.0	18.0

DN (mm)	Q2 (mm)
50	28.5
65	44.0
80	63.5
100	84.0
125	110.5

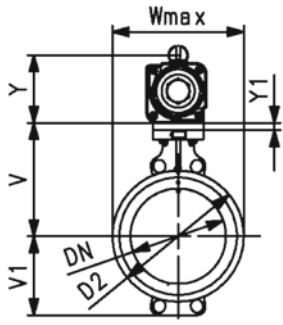

	DN (mm)	Q2 (mm)
	150	137.5
	200	190.5
*	250	239.0
*	300	285.5

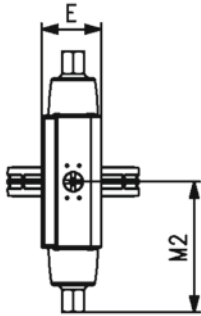
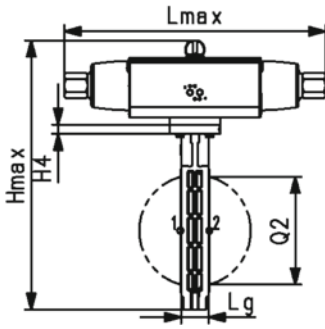

Accessories



Double Sensor for electrical position feedback

After being mounted in the valve or in the interface module, the double sensor is used to signal the CLOSED or OPEN position of the valve via an electric signal to a controller, supplied by the customer. The switching states are also output optically via two integrated LEDs.

Code	Open Signal color	Closed Signal color	Output circuit	Product picture
198546001	LED red	LED green	PNP	
198546002	LED green	LED red	PNP	

i Suitable connection cable code 198546150 available as an accessory.

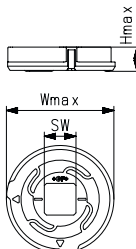

Switching ring for Double Sensor

DN (mm)	Code	Gemäss ISO 5211	SW (mm)	Wmax (mm)	Hmax (mm)	Dimensions	Product picture
50 - 80	199565900	F07	11	57.7	12.5		
100 - 125	199565901	F07	14	57.7	12.5		
150 - 200	199565902	F07	17	57.7	12.5		
250 - 300	199565903	F10	22.1	79.8	12.5		

i For manually operated valves an additional switching ring is required. For electrically or pneumatically operated valves, the switching ring is already pre-assembled.

Hand lever

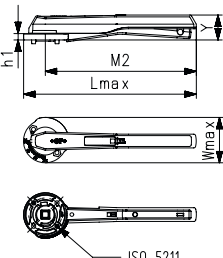
Hand lever incl. fastening screws.

DN (mm)	Code	Wmax (mm)	Lmax (mm)	Gemäss ISO 5211	h1 (mm)	M2 (mm)	Y (mm)	Dimensions	Product picture
50-80	199565906	96	251	F07	13.5	204.5	53		
100-125	199565907	96	301	F07	13.5	254.5	53		
150-200	199565908	96	366	F07	13.5	319.5	53		

Reduction gear

For valve operation via a manual gear with handwheel.

DN (mm)	Code	Product picture
50-200	161483471	
250-300	161483472	

Electric Actuator EA25-250

The EA45/120/250 electric actuator is mounted on a valve (e.g. ball valve or butterfly valve) and connected to a control system provided by the customer. It actuates the valve with a rotary movement of up to 180°.

DN (mm)	Code	Type	Spannung	Torque max.	Acc. to ISO 5211	Product picture
50	198153184	EA45	AC 100-230V	45 Nm	F05* (WS 11/14)	
50	198153185	EA45	AC/DC 24V	45 Nm	F05* (WS 11/14)	
50 - 125	198153186	EA120	AC 100-230V	120 Nm	F07 (WS17)	
50 - 125	198153187	EA120	AC/DC 24V	120 Nm	F07 (WS17)	
150 - 300	198153188	EA250	AC 100-230V	250 Nm	F07 (WS17)	
150 - 300	198153189	EA250	AC/DC 24V	250 Nm	F07 (WS17)	

Smart Actuator dEA45-250

The Smart Actuator dEA45/120/250 is mounted on a valve (e.g. ball valve or butterfly valve) and connected to a control system provided by the customer. It actuates the valve with a rotary movement up to 180°. The Smart Actuator offers wireless connectivity via NFC and Wi-Fi Direct, as well as control and reading of process data via downloadable App.

DN (mm)	Code	Type	Spannung	Torque max.	Acc. to ISO 5211	Product picture
50	198153194	dEA45	AC 100-230V	45 Nm	F05* (WS 11/14)	
50	198153195	dEA45	AC/DC 24V	45 Nm	F05* (WS 11/14)	
50 - 125	198153196	dEA120	AC 100-230V	120 Nm	F07 (WS17)	
50 - 125	198153197	dEA120	AC/DC 24V	120 Nm	F07 (WS17)	
150 - 300	198153198	dEA250	AC 100-230V	250 Nm	F07 (WS17)	
150 - 300	198153199	dEA250	AC/DC 24V	250 Nm	F07 (WS17)	

Pneumatic Actuator PA30-70

The PA30 - PA90 pneumatic actuator can be mounted on any rotary valves with an interface according to ISO 5211.

Single-acting FC

DN (mm)	Code	Type	Torque max.	Acc. to ISO 5211	Product picture
50 - 65	198811617	PA30	30 Nm	F05/07	
80	198811601	PA35	53 Nm	F05/07	
100	198811609	PA40	60 Nm	F05/07	
125	198811603	PA45	90 Nm	F07/10	
150	198811610	PA55	180 Nm	F07/10	
200	198811652	PA60	240Nm	F07/10/12	
250	198811607	PA65	360 Nm	F10/12	
300	198811612	PA70	480 Nm	F10/12	



Single-acting FO

DN (mm)	Code	Typ	Torque max.	Acc. to ISO 5211	Product picture
50 - 65	198811627	PA30	30 Nm	F05/07	
80	198811628	PA35	53 Nm	F05/07	
100	198811629	PA40	60 Nm	F05/07	
125	198811630	PA45	90 Nm	F07/10	
150	198811631	PA55	180 Nm	F07/10	
200	198811653	PA60	240Nm	F07/10/12	
250	198811633	PA65	360 Nm	F10/12	
300	198811634	PA70	480 Nm	F10/12	

Double-acting DA

DN (mm)	Code	Typ	Torque max.	Acc. to ISO 5211	Product picture
50 - 65	198811618	PA35	46 Nm	F03/05	
80	198811619	PA40	60 Nm	F05/07	
100 - 125	198811604	PA45	106 Nm	F05/07	
150	198811606	PA55	180 Nm	F07/10	
200	198811614	PA60	240 Nm	F07/10	
250	198811608	PA65	360 Nm	F07/10	
300	198811615	PA70	480 Nm	F10/12	

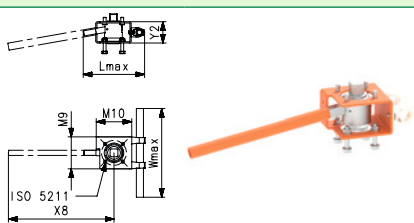
Manual override



DN (mm)	Code	Acc. to ISO 5211	Lmax (mm)	Wmax (mm)	M9 (mm)	M10 (mm)	X8 (mm)	Y2 (mm)	Dimensions	Product picture
50 - 80	199565914	F07	172	250	90	100	298	60		
100 - 125	199565915	F07	172	250	90	100	298	60		
150 - 200	199565916	F07	172	250	90	100	298	60		

Intermediate elements

Intermediate elements are required as a connection between valve and Actuator. The intermediate elements include different screws, hexagon nuts, washer, switching rings, etc. (depends on actuator and dimension).

Note: The switching ring for the double sensor for electrical position feedback is supplied with each intermediate element.

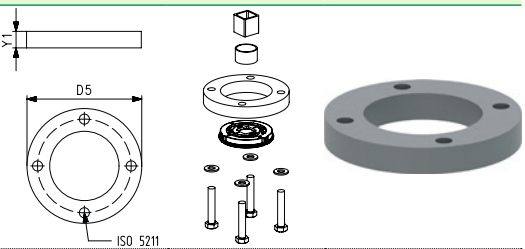
For reduction gear

DN (mm)	Code	Reduction gear	Acc. to ISO 5211	D5 (mm)	Y1 (mm)	Dimensions	Product picture
50 - 80	199565917	161483471	F07	-	-		
100 - 125	199565918	161483471	F07	-	-		
150 - 200	199565919	161483471	F07	-	-		
250 - 300	199565913	161483472	F07/F10	125	17		

For Electric actuators EA45-250, dEA45-250

DN (mm)	Code	Type	Acc. to ISO 5211	D5 (mm)	Y1 (mm)	Dimensions	Product picture
50	199565909	EA45	F05/F07	90	15		
50 - 80	199565910	xEA120-250	F07	-	-		
100 - 125	199565911	xEA120-250	F07	-	-		
150 - 200	199565912	xEA250	F07	-	-		
250 - 300	199565913	xEA250	F07/F10	125	17		

For Pneumatic actuators, function FC/F0

DN (mm)	Code	Type	Acc. to ISO 5211	D5 (mm)	Y1 (mm)	Dimensions	Product picture
50	199565921	PA30	F05/F07	90	15		
65	199565921	PA30	F05/F07	90	15		
80	199565922	PA35	F05/F07	90	15		
100	199565923	PA40	F07	-	-		
125	199565924	PA45	F07	-	-		
150	199565925	PA50	F07	-	-		
200	199565929	PA60	F07/F10	125	18		
250	199565927	PA65	F10	125	18		
300	199565928	PA70	F10	125	18		

For Pneumatic actuators, function DA

DN (mm)	Code	Type	Acc. to ISO 5211	D5 (mm)	Y1 (mm)	Dimensions	Product picture
50	199565920	PA35	F05/F07	90	15		
65	199565920	PA35	F05/F07	90	15		
80	199565921	PA40	F05/F07	90	15		
100	199565923	PA45	F07	-	-		
125	199565923	PA45	F07	-	-		
150	199565925	PA55	F07	-	-		
200	199565925	PA60	F07	125	18		
250	199565926	PA65	F10	125	18		
300	199565927	PA70	F10	125	18		

Replacement parts

Replacement seat liner

DN (mm)	EPDM	FKM	Lmax (mm)	Wmax (mm)	Dimensions	Product picture
50	199565930	199565940	45.2	85.5		
65	199565931	199565941	48.4	105.5		
80	199565932	199565942	48.4	122.5		
100	199565932	199565943	54.6	142.5		
125	199565934	199565944	59	169.5		
150	199565935	199565945	59	194.5		
200	199565936	199565946	63	248		
250	199565937	199565947	72	304		
300	199565938	199565948	82.8	358		

Replacement o-ring

DN (mm)	EPDM	FKM	Di	s	Dimensions	Product picture
50-80	199565951	199565961	13.95	2.62		
100-125	199565952	199565962	17.13	2.62		
150-200	199565953	199565963	20.22	3.53		
250-300	199565954	199565964	24.99	3.53		

i For further information see www.gfps.com/565

■ Mobile apps and online tools to support configuration and calculation at www.gfps.com/tools



The information and technical data (altogether "Data") herein are not binding, unless explicitly confirmed in writing. The Data neither constitutes any expressed, implied or warranted characteristics, nor guaranteed properties or a guaranteed durability. All Data is subject to modification. The General Terms and Conditions of Sale of Georg Fischer Piping Systems apply.

02/2021-A

© Georg Fischer Piping Systems Ltd, 8201 Schaffhausen/Switzerland
Tel. +41 52 631 11 11 • www.gfps.com • E-Mail: info.ps@georgfischer.com

Notes

Worldwide at home

Our sales companies and representatives ensure local customer support in more than 100 countries.

www.gfps.com

Argentina / Southern South America

Georg Fischer Central Plastics Sudamérica S.R.L.
Buenos Aires / Argentina
Phone +54 11 4512 02 90
gfccentral.ps.ar@georgfischer.com
www.gfps.com/ar

Australia

Georg Fischer Pty Ltd
Riverwood NSW 2210
Phone +61 (0) 2 9502 8000
australia.ps@georgfischer.com
www.gfps.com/au

Austria

Georg Fischer Rohrleitungssysteme GmbH
3130 Herzogenburg
Phone +43 (0) 2782 856 43-0
austria.ps@georgfischer.com
www.gfps.com/at

Belgium / Luxembourg

Georg Fischer NV/SA
1600 Sint-Pieters-Leeuw / Belgium
Phone +32 (0) 2 556 40 20
Fax +32 (0) 2 524 34 26
be.ps@georgfischer.com
www.gfps.com/be

Brazil

Georg Fischer Sist. de Tub. Ltda.
04571-020 São Paulo/SP
Phone +55 (0) 11 5525 1311
br.ps@georgfischer.com
www.gfps.com/br

Canada

Georg Fischer Piping Systems Ltd
Mississauga, ON L5T 2B2
Phone +1 (905) 670 8005
Fax +1 (905) 670 8513
ca.ps@georgfischer.com
www.gfps.com/ca

China

Georg Fischer Piping Systems Ltd
Shanghai 201319
Phone +86 21 3899 3899
china.ps@georgfischer.com
www.gfps.com/cn

Denmark / Iceland

Georg Fischer A/S
2630 Taastrup / Denmark
Phone +45 (0) 70 22 19 75
info.dk.ps@georgfischer.com
www.gfps.com/dk

Finland

Georg Fischer AB
01510 Vantaa
Phone +358 (0) 9 586 58 25
Fax +358 (0) 9 586 58 29
info.fi.ps@georgfischer.com
www.gfps.com/fi

France

Georg Fischer SAS
95932 Roissy Charles de Gaulle Cedex
Phone +33 (0) 1 41 84 68 84
fr.ps@georgfischer.com
www.gfps.com/fr

Germany

Georg Fischer GmbH
73095 Albershausen
Phone +49 (0) 7161 302 0
info.de.ps@georgfischer.com
www.gfps.com/de

India

Georg Fischer Piping Systems Pvt. Ltd
400 083 Mumbai
Phone +91 22 4007 2000
Fax +91 22 4007 2020
branchoffice@georgfischer.com
www.gfps.com/in

Indonesia

PT Georg Fischer Indonesia
Karawang 41371, Jawa Barat
Phone +62 267 432 044
Fax +62 267 431 857
indonesia.ps@georgfischer.com
www.gfps.com/id

Italy

Georg Fischer S.p.A.
20864 Agrate Brianza (MB)
Phone +39 02 921 86 1
Fax +39 02 921 86 24 7
it.ps@georgfischer.com
www.gfps.com/it

Japan

Georg Fischer Ltd
530-0003 Osaka
Phone +81 (0) 6 6341 2451
jp.ps@georgfischer.com
www.gfps.com/jp

Korea

Georg Fischer Korea Co. Ltd
Unit 2501, U-Tower
120 Heungdeok Jungang-ro
(Yeongdeok-dong)
Giheung-gu, Yongin-si, Gyeonggi-do
Phone +82 31 8017 1450
Fax +82 31 217 1454
kor.ps@georgfischer.com
www.gfps.com/kr

Malaysia

Georg Fischer (M) Sdn. Bhd.
41200 Klang, Selangor Darul Ehsan
Phone +60 (0) 3 3122 5585
Fax +60 (0) 3 3122 5575
my.ps@georgfischer.com
www.gfps.com/my

Mexico / Northern Latin America

Georg Fischer S.A. de C.V.
CP 66603 Apodaca, Nuevo León / Mexico
Phone +52 (81) 1340 8586
Fax +52 (81) 1522 8906
mx.ps@georgfischer.com
www.gfps.com/mx

Middle East

Georg Fischer Piping Systems (Switzerland) Ltd
Dubai / United Arab Emirates
Phone +971 4 289 49 60
gcc.ps@georgfischer.com
www.gfps.com/int

Netherlands

Georg Fischer N.V.
8161 PA Epe
Phone +31 (0) 578 678 222
nl.ps@georgfischer.com
www.gfps.com/nl

New Zealand

Georg Fischer Ltd
5018 Upper Hutt
Phone +04 527 9813
Fax +04 527 9834
nz.ps@georgfischer.com
www.gfps.com/nz

Norway

Georg Fischer AS
1351 Rud
Phone +47 67 18 29 00
no.ps@georgfischer.com
www.gfps.com/no

Philippines

George Fischer Pte. Ltd.
Philippines Representative Office
1500 San Juan City
Phone +632 571 2365
Fax +632 571 2368
sgp.ps@georgfischer.com
www.gfps.com/sg

Poland

Georg Fischer Sp. z o.o.
05-090 Sekocin Nowy
Phone +48 (0) 22 31 31 0 50
poland.ps@georgfischer.com
www.gfps.com/pl

Romania

Georg Fischer Piping Systems (Switzerland) Ltd
020257 Bucharest - Sector 2
Phone +40 (0) 21 230 53 80
ro.ps@georgfischer.com
www.gfps.com/int

Russia

Georg Fischer Piping Systems (Switzerland) Ltd
Moscow 125040
Phone +7 495 748 11 44
ru.ps@georgfischer.com
www.gfps.com/ru

Singapore

Georg Fischer Pte Ltd
528 872 Singapore
Phone +65 6747 0611
Fax +65 6747 0577
sgp.ps@georgfischer.com
www.gfps.com/sg

Spain / Portugal

Georg Fischer S.A.
28046 Madrid / Spain
Phone +34 (0) 91 781 98 90
es.ps@georgfischer.com
www.gfps.com/es

Sweden

Georg Fischer AB
117 43 Stockholm
Phone +46 (0) 8 506 775 00
info.se.ps@georgfischer.com
www.gfps.com/se

Switzerland

Georg Fischer Rohrleitungssysteme (Schweiz) AG
8201 Schaffhausen
Phone +41 (0) 52 631 3026
ch.ps@georgfischer.com
www.gfps.com/ch

Taiwan

Georg Fischer Co. Ltd
San Chung Dist., New Taipei City
Phone +886 2 8512 2822
Fax +886 2 8512 2823
www.gfps.com/tw

United Kingdom / Ireland

George Fischer Sales Limited
Coventry, CV2 2ST / United Kingdom
Phone +44 (0) 2476 535 535
uk.ps@georgfischer.com
www.gfps.com/uk

USA / Caribbean

Georg Fischer LLC
92618 Irvine, CA / USA
Phone +1 714 731 8800
Fax +1 714 731 6201
us.ps@georgfischer.com
www.gfps.com/us

Vietnam

Georg Fischer Pte Ltd
Representative Office
Ho Chi Minh City
Phone +84 28 3948 4000
Fax +84 28 3948 4010
sgp.ps@georgfischer.com
www.gfps.com/vn

International

Georg Fischer Piping Systems (Switzerland) Ltd
8201 Schaffhausen / Switzerland
Phone +41 (0) 52 631 3003
Fax +41 (0) 52 631 2893
info.export@georgfischer.com
www.gfps.com/int

The information and technical data (altogether "Data") herein are not binding, unless explicitly confirmed in writing. The Data neither constitutes any expressed, implied or warranted characteristics, nor guaranteed properties or a guaranteed durability. All Data is subject to modification. The General Terms and Conditions of Sale of Georg Fischer Piping Systems apply.

